

avantgarde
ACOUSTIC

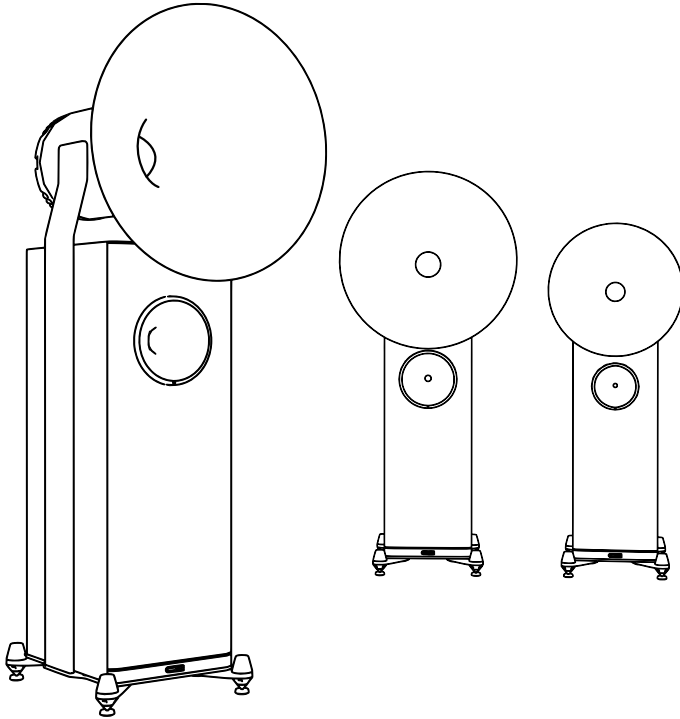

User Manual

UNO SD & DUO SD & DUO GT

Version 1.1

Listen & Love

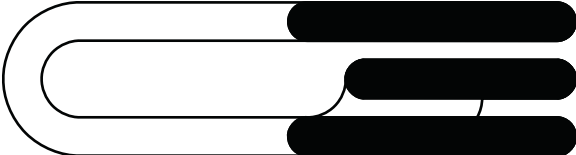

TABLE OF CONTENTS

SAFETY INFORMATION

SAFETY INFORMATION	6
PRECAUTIONS ON INSTALLATION	7
OPERATING VOLTAGE	7

SET UP

CONTENT OF PACKAGES	8
UNPACKING	10
ADJUSTABLE FEET & SPIKES	12
ANGLE ADJUSTABLE FEET & SPIKES	13

OPERATION

SAFETY PRECAUTIONS	14
CONNECTION PASSIVE VERSION – SINGLE WIRING	16
CONNECTION PASSIVE VERSION – BI WIRING	17
CONNECTION ITRON VERSION – BALANCED XLR	18
ON & OFF SWITCH	19
OPERATION ITRON – AUDIO SOUND ADJUSTMENTS	20
OPERATION ITRON – GAIN ADJUSTMENTS	21

OPERATION DSP SUBWOOFER AMP

SPEAKER LEVEL INPUTS	22
BALANCED INPUTS	23
INPUT SELECT SWITCH	24
LED BRIGHTNESS CONTROL	24
POWER MODE SWITCH	25
DSP VOLUME CONTROL	26
DSP SOFTWARE INSTALLATION	27
DSP USER INTERFACE	28
DSP SETTINGS	29

FINE TUNING

ROOM PLACEMENT	30
TOE-IN & TOE-OUT	31
LISTENING HEIGHT	32
BURN IN TIME	32

MISCELLANEOUS

12V DC TRIGGER	33
E-FUSE	33
FUTURE UPGRADES	33
CLEANING	34
WARRANTY	35



SAFETY INFORMATION

CAUTION



To prevent fire, shock or damage, do not expose the components to rain or moisture.



Conditions for operation:

room temperature 5 – 35° C,
humidity 10 – 75%

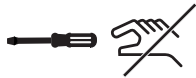

It is intended to alert the user of the presence of uninsulated “dangerous voltage” within the products enclosure. To avoid electrical shock, do not open the cabinet of the components.



Excessive sound pressure levels might cause serious damage to your health. Do not operate the speaker system at excessive levels for a long period of time.

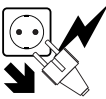

Should any solid object or liquid fall into the cabinet of the components, unplug the unit and have it checked by qualified personnel before operating it any further.



Unplug the components of your system from the wall outlet and antenna if they are not to be used for an extended period of time. To disconnect the power cord, pull it out by the plug. Do not pull the cord itself. Never touch the plugs with wet hands.



Only let qualified personnel repair or reassemble the components of the system.

PRIVATE USE ONLY

These loudspeakers are designed for the playback of audio signals for “Home & Office use” only. Any other use, especially in commercial applications, is expressly prohibited.



SAFETY INFORMATION

PRECAUTIONS ON INSTALLATION

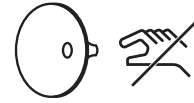

Do not move or carry the speakers by holding the horn assembly.



Place the components of the system on a flat solid surface.

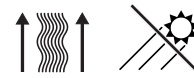

To prevent internal heat build-up in the components, place units in a location with sufficient air circulation. Do not install the speakers in a location near heat sources such as radiators, or in a place subject to direct sunlight, excessive dust, or mechanical vibration.



Connect everything securely. Always insert the plugs fully into the jacks. A loose connection may cause hum pick-up and can damage the system. Use only high-quality cables with self-tightening banana speaker and RCA or XLR plugs.

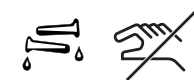

To avoid damaging the finish, never use alcohol, paint thinner or chemicals to clean the components.



Read this operators manual thoroughly before operating the speaker system.







OPERATING VOLTAGE



The electronic components & amplifiers are suitable for operating voltages ranging from 90 – 250 Volt at 50 or 60 Hz.



CONTENT OF PACKAGES

UNO SD, DUO SD & DUO GT

2 x		2 x cardboard box with the 2 x speakers.
8 x		8 x feet with Teflon glides (installed in the foot frame mechanism of the speaker on delivery).
8 x		8 x spikes, as an alternative to the standard feet.
8 x		8 x protective plates (with center hole) for the spikes, to protect sensitive floors from damage.
8 x		8 x lock nuts to secure/lock the feet & spikes.
1 x		1 x Tool to adjust the lock nuts, equipment feet & spikes.
1 x		1 x user manual

CONTENT OF PACKAGES

UNO SD, DUO SD & DUO GT

2 x		2 x power cable (3m) for passive version
4 x		4 x power cable (3m) for iTRON version
2 x		2 x 0,8m SPKR cable between bass amplifier & passive crossover. <i>(Passive version only)</i>
2 x		2 x 0.8m XLR cable between bass amplifier & iTRON module. <i>(iTRON version only)</i>

UNPACKING

UNO SD & DUO SD



Please note the very heavy weight of the speaker system when unpacking and installing the system! We strongly advise doing this work only with the help of other persons!



Do not move or carry the speakers by holding the horn assembly. The horns may get damaged.

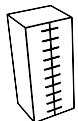

- ① Place the packaging carton upright, remove the clips and open the carton.

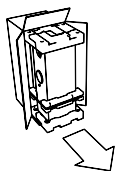

- ② Carefully pull the loudspeaker forward using recessed grips.

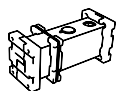

- ③ Carefully lay the loudspeaker on its back.

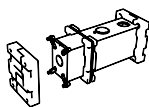

- ④ Remove the lower EPP packaging protection.

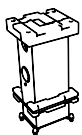

- ⑤ Carefully lift the speaker to the upright position and remove the EPP packaging protection.

- ⑥ Use a wheel board (minimum size 70 x 70 cm) to transport the loudspeaker to its listening position. Note that the spherical horns can be removed by unscrewing them counterclockwise. This makes it easier to pass through narrow doorways.

UNPACKING

DUO GT



Please note the very heavy weight of the speaker system when unpacking and installing the system! We strongly advise doing this work only with the help of other persons!



Do not move or carry the speakers by holding the horn assembly. The horns may get damaged.

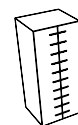

- ① Place the packaging carton upright, remove the clips and open the carton.



- ② Carefully pull the loudspeaker forward using recessed grips.

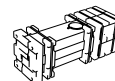

- ③ Carefully lay the loudspeaker on its back.

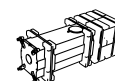

- ④ Remove the lower EPP packaging protection.



- ⑤ Carefully lift the speaker to the upright position and remove the EPP packaging protection.



- ⑥ Use a wheel board (minimum size 70 x 70 cm) to transport the loudspeaker to its listening position. Note that the spherical horns can be removed by unscrewing them counterclockwise. This makes it easier to pass through narrow doorways.

HEIGHT ADJUSTMENT OF FEET

UNO SD, DUO SD & DUO GT

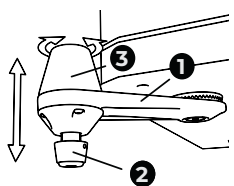

The loudspeaker stands on 4 x rotatable base frame arms **1**. On delivery, standard feet with Teflon glides **2** are installed.

After the final installation of the speaker, adjust the height of the feet by turning the handle **3** clockwise to level the speaker.

OPTIONAL SPIKE

UNO SD, DUO SD & DUO GT

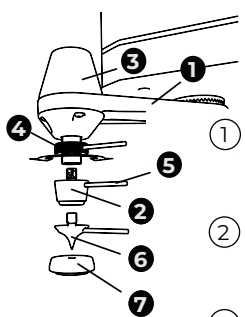

Alternatively, the optional spikes **6** can be installed instead of the standard feet **2**. For this work, we strongly recommend the assistance of a second person!

- 1 One person carefully tilts the speaker backwards. The front two feet will float in the air.
- 2 The second person can now unscrew the standard feet **2** by turning them counterclockwise using the tool **5**.
- 3 If desired, screw in the lock nuts **4** using the tool **5** to fix the height adjustment of the spikes.
- 4 Screw in the spikes **6** clockwise with the help of the tool. If necessary, use the protective washers **7** to protect sensitive floors from damage.
- 5 After mounting the front spikes **6**, now carefully tilt the speaker forward and replace the rear feet accordingly.
- 6 After the speaker is finally set up, adjust the height by turning the handle **3** clockwise to level the speaker.
- 7 Firmly tighten the lock nuts **4** to fix the height adjustment.

ANGLE ADJUSTMENT OF FEET

UNO SD, DUO SD & DUO GT

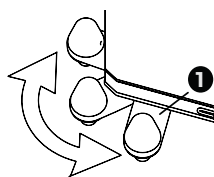

On delivery, the 4 x rotatable base frame arms **1** are mounted on the loudspeaker at a 45 degree angle.

The angle of the arms **1** can be adjusted in 7.5 degree steps by the precision Hirth toothing. For this work, we strongly recommend the assistance of a second person!

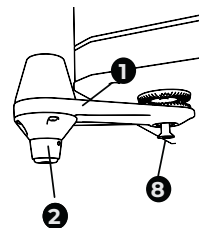

- 1 One person carefully tilts the speaker backwards. The front two feet will then float in the air.
- 2 The second person can now loosen the mounting screw **3** of the Hirth gear and turn the base frame arms **1** to the desired position.
- 3 Tighten the mounting screw **3** again.
- 4 After adjusting the angle of the front foot stand booms, now carefully tilt the speaker forward and adjust the rear base frame arms **1** accordingly.



SAFETY PRECAUTIONS

ON INSTALLATION



The power to all components must be switched "off" (or disconnected from the household AC) before making any audio connections.



To prevent malfunction/defects, do not operate components with open input/output terminals.



Control the polarity of speaker cables! Never mix up "+" and "-". Wrong polarity will deteriorate the sound quality and can damage amplifier and the active power module of the subwoofer.

Do not short circuit the +/- electric poles of the speaker cables.

Use high quality cable with solid speaker plugs (spades, bananas etc).

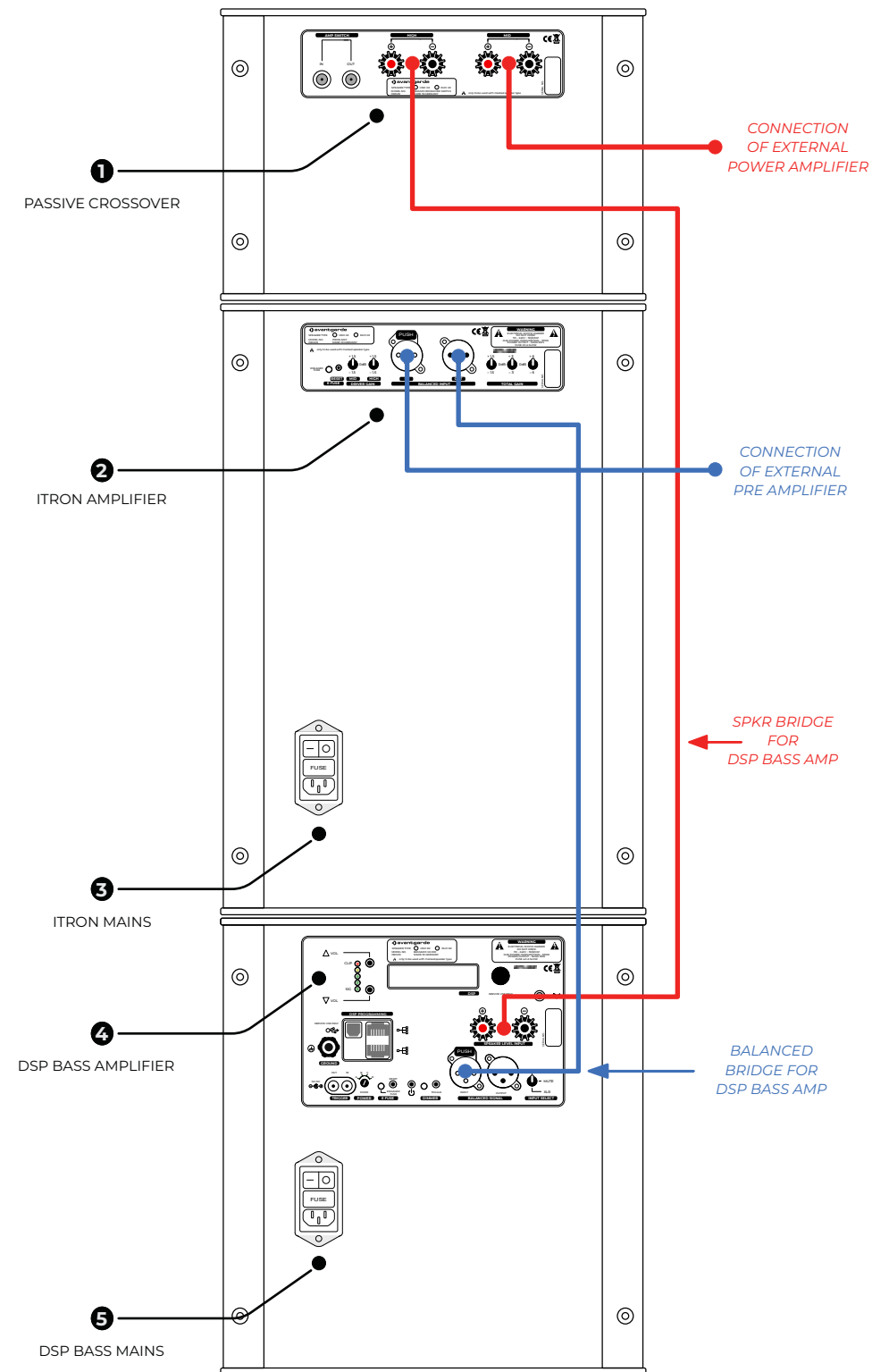

CONNECTION – PASSIVE VERSION

SINGLE-WIRING

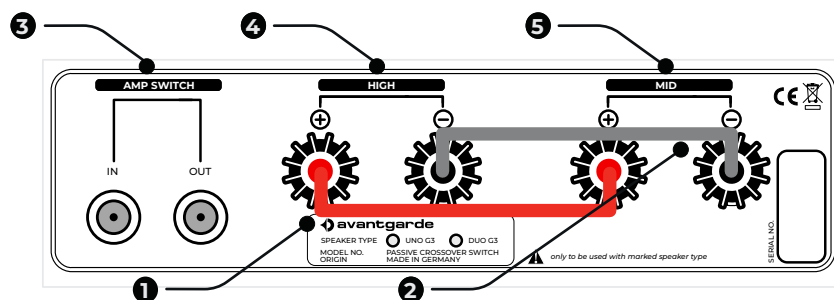

High ④ and mid ⑤ have separate speaker terminals. In the standard configuration these connectors interconnected with 2 x OFC 2-way bridges ①&②. One bridge ① interconnects all "+" terminals, the other bridge ② interconnects all "-" terminals.

- ① Connect the Speaker-Output of your power (or integrated) amplifier to the Speaker-MID connector ⑤ of the speakers.
- ② Connect the HIGH terminal ④ of the speaker and the speaker input terminals of the DSP subwoofer amplifier with the jumper cable. The jumper cable is included in the accessory box.
- ③ Only now connect the components' power cords to a household outlet and turn on the subwoofer and other equipment.

• The inputs and outputs of the AMP SWITCH ③ are exclusively available on devices with ITRON amplifier (incl. the AMP SWITCH circuitry) and are used for remote switching between PASSIVE crossover and ITRON amplifier.

CONNECTION – PASSIVE VERSION

BI-WIRING

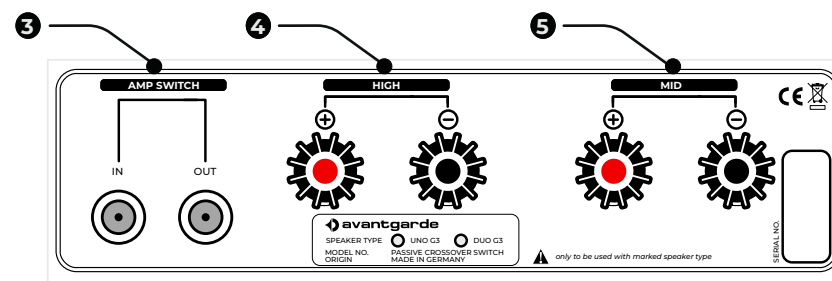

- ① To operate the system in BI-Wiring or BI-Amping mode, the 2 x OFC 2-way bridges ①&② must be removed.

- ② Open the screw caps of the tweeter ④ and midrange ⑤ speaker terminals and remove the two OFC 2-way bridges ①&②.

- ③ Connect the speaker output of your power amplifier (or integrated amplifier) to the speaker terminals of the loudspeaker, using a separate cable for each terminal. The same applies if you are using multiple amplifiers for treble and midrange.

- ④ Connect the HIGH terminal ④ of the speaker and the speaker input terminals of the DSP subwoofer amplifier with the jumper cable. The jumper cable is included in the accessory box.

• The jumper cables have hollow banana plugs which are open at the rear. This way it is possible to stack multiple speaker cables to the same speaker terminal.

- ⑤ Only now connect the components' power cords to a household outlet and turn on the subwoofer and other equipment.

• The inputs and outputs of the AMP SWITCH ③ are exclusively available on devices with ITRON amplifier (incl. the AMP SWITCH circuitry) and are used for remote switching between PASSIVE crossover and ITRON amplifier.

CONNECTION – ITRON VERSION

BALANCED XLR CONNECTION

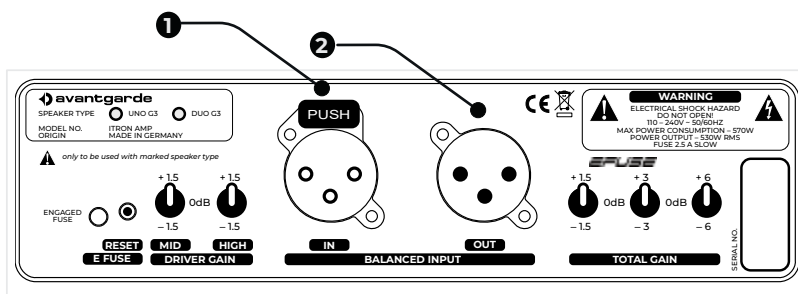

Line level connections feature balanced XLR connectors/terminals. The pin assignment of these follows the EIA RS-297-A standard: PIN 1 = GND, PIN 2 = HOT, PIN 3 = COLD. Never use cables with differing pin assignment! This will deteriorate the sound quality and can damage the amplifiers and/or the active power modules of the subwoofers.

- 1 Connect the line level output of your preamplifier with the balanced line level input **1** of the ITRON amplifier with an XLR cable.
- 2 Connect the balanced XLR daisy-chain output of the iTRON amplifier **2** and the balanced XLR input of the DSP subwoofer amplifier with the XLR jumper cable. The jumper cable is included in the accessory box.
- 3 Only now, connect the AC power **3** of the components to a household AC outlet and turn on the ITRON module **4** and the subwoofer DSP amplifier.

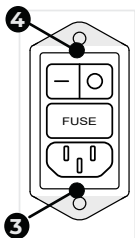

OPERATION – POWER SWITCH

ON/OFF

- 1 The power switch **4** has an "O" OFF position and a "I" ON position. Switch it to the ON position for operation.
- 2 The speaker has an illuminated push button **5** on the front below the tweeter to turn on the speaker.

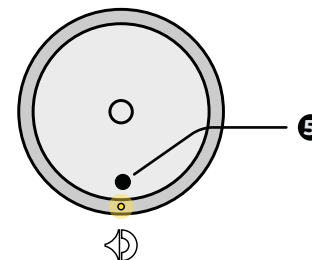

ORANGE = Standby
 WHITE = ON
 PURPLE = OTA-Firmware Update (*future upgrade*)

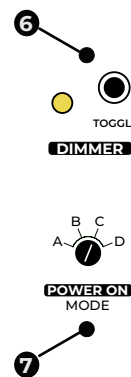

- 3 The brightness of the light can be switched between 8 x intensities using the DIMMER TOGGLE button **6** of the DSP subwoofer amplifier.
- 4 The POWER-ON mode switch **7** of the DSP subwoofer amplifier can be used to select 4 different power on/off modes. See description of the subwoofer DSP amplifier.

OPERATION – ITRON VERSION

AUDIO SOUND ADJUSTMENTS

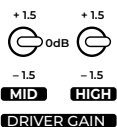
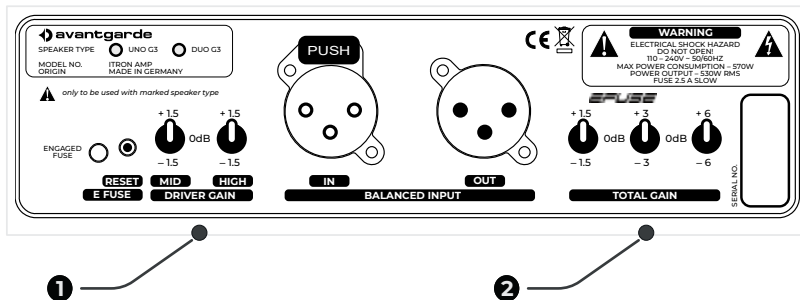

The 2 x DRIVER GAIN switches ① allow the volume of the 2 x horns to be adjusted in -1.5 dB, 0 dB (= linear) and +1.5 dB steps.

MID controls the level of the midrange horn (approx. 200–4,000 Hz)
HIGH controls the level of the high frequency horn (above 4,000 Hz)

The factory setting is the "0 dB" position for all 2 switches.

Adjustments can be made according to personal taste, to match the tonal "tonality" of the connected source equipment, or to slightly correct for room acoustic influences.

In practice, the tonal balance between the 2 x frequency bands can be changed by up to 3 dB. Example:

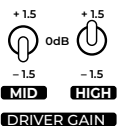

If the HIGH switch is set to +1.5 dB and the MID switch is set to -1.5 dB, the relative loudness of the midrange speaker compared to the tweeter horn is reduced by 3 dB. This could be used as a beneficial voicing for "shrill" recordings (with overemphasized midrange) or in an acoustic environment with a "peak" in the midrange.

OPERATION – ITRON VERSION

GAIN ADJUSTMENTS

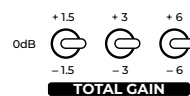

The 3 x TOTAL GAIN switches ② allow the adjustment of the gain of the speakers to the strength of the line level signal from the connected preamp. To avoid sound degrading potentiometers in the signal path, 3 x switches in an additive stepped arrangement are being used. Factory default is the "0 dB" position for all 3 switches.

Practical example: If a preamp already makes big "jumps" in sound level by turning the volume knob just slightly, reducing the ITRON's input gain by up to -10.5 dB may increase the adjustment angle of the pre amps volume knob considerably, thus enhancing its practical usefulness for fine volume adjustments.

The following steps are possible:

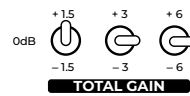

+/- 1.5 dB = left switch in "+" or "-" position

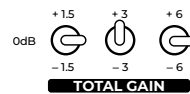

+/- 3 dB = central switch in "+" or "-" position

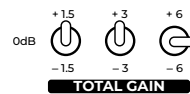

+/- 4.5 dB = central & left in "+" or "-" position

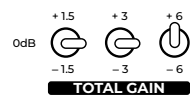

+/- 6 dB = right switch in "+" or "-" position

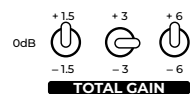

+/- 7.5 dB = right & left in "+" or "-" position

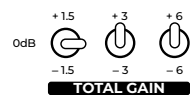

+/- 9 dB = right & central in "+" or "-" position

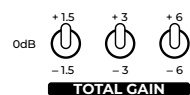

+/- 10.5 dB = all 3 switches in "+" or "-" position

CONNECTION – SUBWOOFER DSP AMP PASSIVE VERSION – SPEAKER LEVEL INPUTS

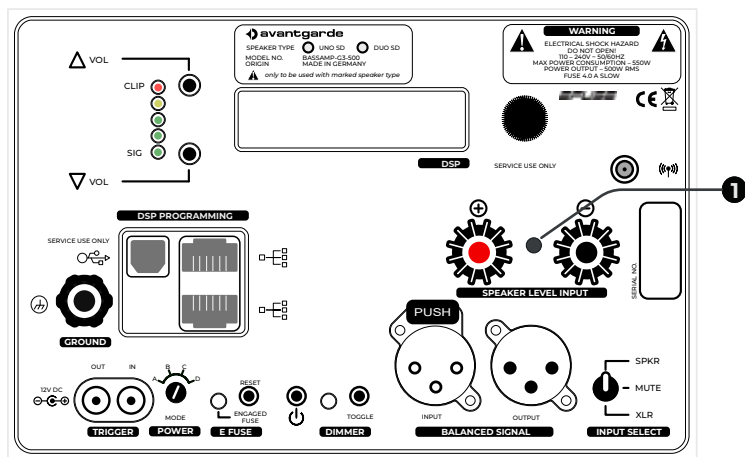

- 1 In the passive version, the speaker is operated via an external power amplifier. This amplifier is connected to the speaker MID connector of the speaker via a high-quality speaker cable.
- 2 The jumper cable (included in the accessory box) is used to connect the signal from the speaker HIGH connector of the speaker (see page 16) to the speaker level input 1 of the DSP subwoofer amplifier.

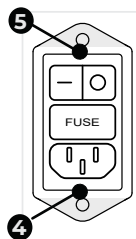

- 3 Only now, connect the AC power 4 of the components to a household AC outlet and turn on 5 the subwoofer DSP amplifier.

CONNECTION – SUBWOOFER DSP AMP ITRON VERSION – BALANCED XLR INPUT

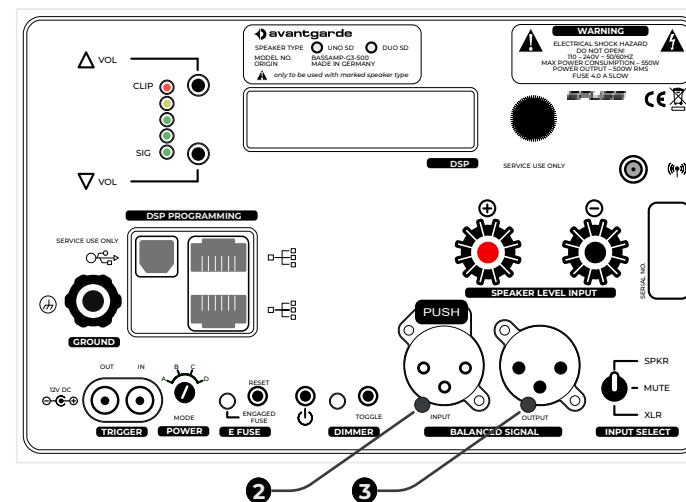

Line level connections feature balanced XLR connectors/terminals. The pin assignment of these follows the EIA RS-297-A standard: PIN 1 = GND, PIN 2 = HOT, PIN 2 = COLD. Never use cables with differing pin assignment! This will deteriorate the sound quality and can damage the amplifiers and/or the active power modules of the subwoofers.

- 1 In the active iTRON version, the loudspeaker is driven by an external preamplifier. For this purpose, the line-level output of the preamplifier is connected to the balanced line-level input of the iTRON amplifier with an XLR cable (see page 18).
- 2 The XLR jumper cable (included in the delivery box) connects the balanced XLR daisy chain output of the iTRON amplifier to the balanced XLR input 2 of the DSP subwoofer amplifier.
- 3 Only now, connect the AC power 4 of the components to a household AC outlet and turn on the iTRON module 5 and the subwoofer DSP amplifier.

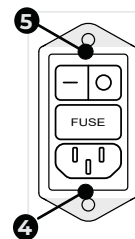

OPERATION – SUBWOOFER DSP AMP

POWER SWITCH, INPUT SELECT SWITCH & LED BRIGHTNESS

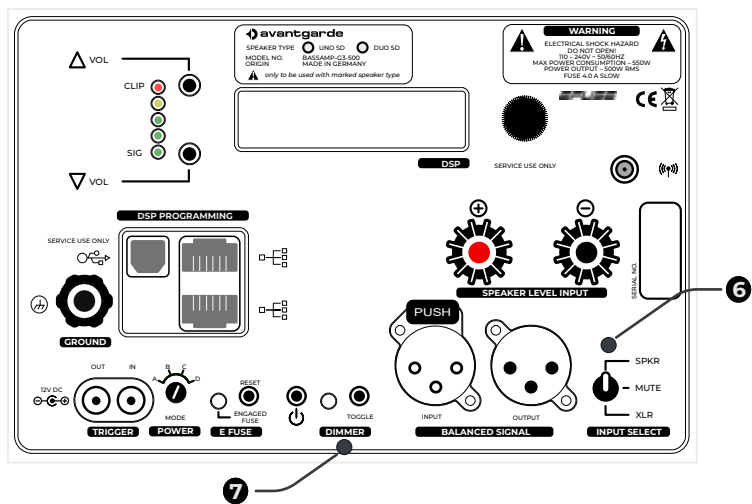

POWER SWITCH

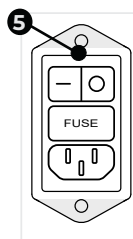

The mains power switch **5** has an “0” OFF-position & an “1” ON-position. For operation switch to the ON position. If the SPACEHORN is not being used for a longer time, switch the system to the “0” OFF-position.

INPUT SELECT SWITCH

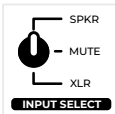

Speaker Level & balanced inputs can be connected in parallel. With the Input-Select switch **6** the respective input can be selected.

The Input-Select switch **6** also has a MUTE-position, which mutes the inputs. This can be helpful during troubleshooting (e.g. when hum occurs).

LED BRIGHTNESS CONTROL



The brightness of the LED light can be adjusted with the DIMMER TOGGLE button **7**, toggling through 8 x intensities.

OPERATION – SUBWOOFER DSP AMP

POWER MODE SETTINGS

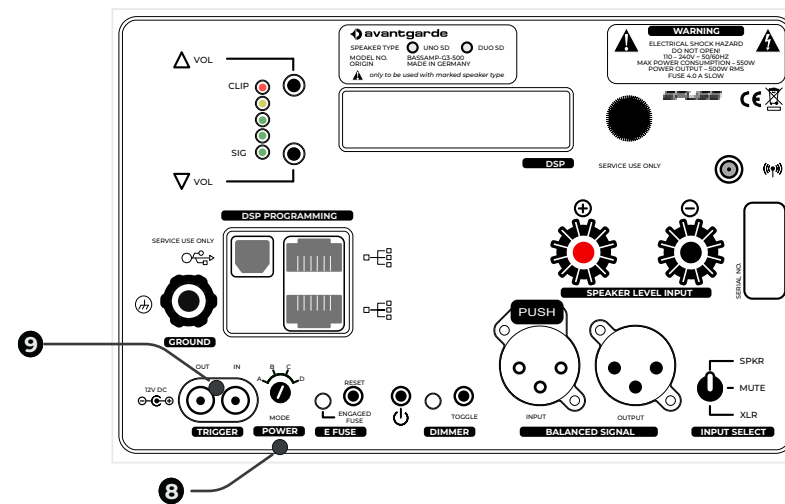

POWER MODE SWITCH

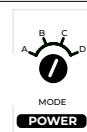

4 x different power ON/OFF modes can be selected with the POWER ON mode selector **8**. Use a screwdriver to switch the modes.

newly selected modes will only become active after the mains power switch **5** has been switched OFF & ON again.

MODE A speaker is ON upon powering it up with the mains power switch **5**. To be used for remote controlled AC power sockets.

MODE B speaker is ON when a 12VDC trigger voltage is detected at the remote-trigger socket **9**. The speaker will automatically switch OFF, when the 12V trigger voltage is switched OFF.

MODE C the illuminated pushbutton on the front of the loudspeaker (see page 19), is used to toggle between ON & STANDBY.

MODE D speaker is switched ON & STANDBY by remote control signal (optional future upgrade only).

OPERATION – SUBWOOFER DSP AMP

DSP VOLUME SETTINGS

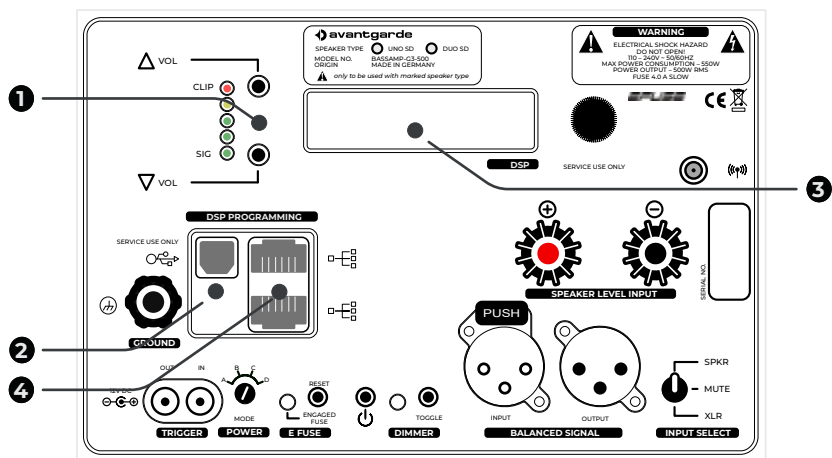

The bass response of the speaker will be influenced by the room and the position of the speaker. This might cause the bass response of the speaker to be strengthened or weakened. Thus as the first step, the overall bass volume needs to be aligned to compensate these effects.

- 1 Press the VOL ▲-button 1 to increase or the VOL ▼-button 1 to reduce the volume of the bass response. The set volume is indicated in the display 3.

OPERATION – SUBWOOFER DSP AMP

DSP SOFTWARE INSTALLATION



Additional settings can be programmed with the Avantgarde Control software.

The software can be requested by email at our service desk: info@avantgarde-acoustic.de

LAN CONNECTION TO PC

- 1 Each SPACEHORN amplifier features 2 x LAN sockets which allow to daisy chain multiple subwoofers.
- 2 Connect the LAN ports 4 of all SPACEHORNS with each other using LAN-cable (type CAT5/6/7/8).
- 3 Connect a free LAN port 4 of one SPACEHORN with the LAN port of your computer or with the LAN port of your WIFI router. The Avantgarde Control software installed on your computer/laptop will automatically detect and display all available subwoofer amps.

USB CONNECTION TO PC

USB port 2 for service use only.

IMPORTANT!



The LAN and the USB connectors are not suitable for the connection of music sources!

OPERATION – SUBWOOFER DSP AMP

DSP USER INTERFACE

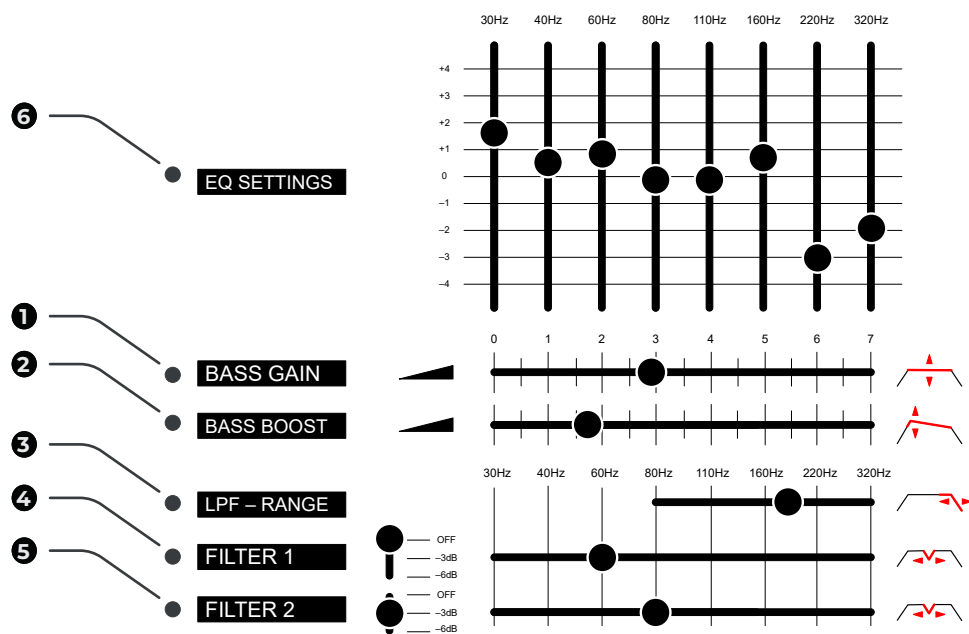

Please note that all changes in the Avantgarde control software immediately become audible in the speaker. This way it is easy to verify the changes by listening and fine adjust if required.

OPERATION – SUBWOOFER DSP AMP

DSP SETTINGS

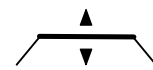

The BASS GAIN slider **1** sets the overall volume of the subwoofer.



The BASS BOOST slider **2** increases the low frequency response below 45 Hz. This allows to tailor the bass response from “linear” to “fat”.



For individual frequency settings use the 8 x band equalizer **6**. Each of the 8 x bands can be increased or decreased by up to 4dB. This can be used to tailor your bass response to specific sounds (linear, techno, disco, pop, etc.) or to reduce some wide-band room resonances.

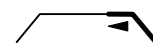

The LPF-RANGE slider **3** sets the upper crossover frequency of the subwoofer. The crossover frequency in its factory setting is linear. The frequency response of the subwoofer seamlessly crosses over to the frequency response of the midrange horn. Both response curves do not overlap and there is no gap inbetween. The crossover point can be used to adjust the “tonal balance” of the system.

- 1** When set to a higher frequency, the subwoofer will partly overlap with the midrange horn response. This will add “warmth” and give a richer “body” to the sound character of certain voices and instruments.
- 2** If the crossover frequency is purposely set to a lower frequency, subwoofer and midrange frequency response will have a small gap. The tonal balance of the system will shift to a more horn typical “dynamic” and “punchy” sound.



FILTER 1 & 2 **4 5** are narrow band “notch” filters with a negative gain of -3dB or -6dB. These filters can be used to eliminate/reduce unwanted narrow band resonance frequencies of the room.

- 1** Use commonly available frequency sweep apps to detect the position (Hz) of possibly occurring room resonances. Or play bass heavy music through your system and slowly slide the FILTER set at -6dB upwards until the “boominess” improves.

FINE TUNING

ROOM PLACEMENT

Due to the controlled dispersion characteristics of the horns the speaker will excite significantly less unwanted reflections from the room walls compared to conventional speakers. Thus they can be positioned closely to back walls or corners (both or only one speaker in the corner!).

Choose a position for the speakers in your listening room. Both speakers and your listening seat should form an approx. equilateral triangle. Ideally each side of the triangle should be approx. 3,0 – 4,0m.

The speakers should be toed-in with the midrange horns pointing directly to the listening position.

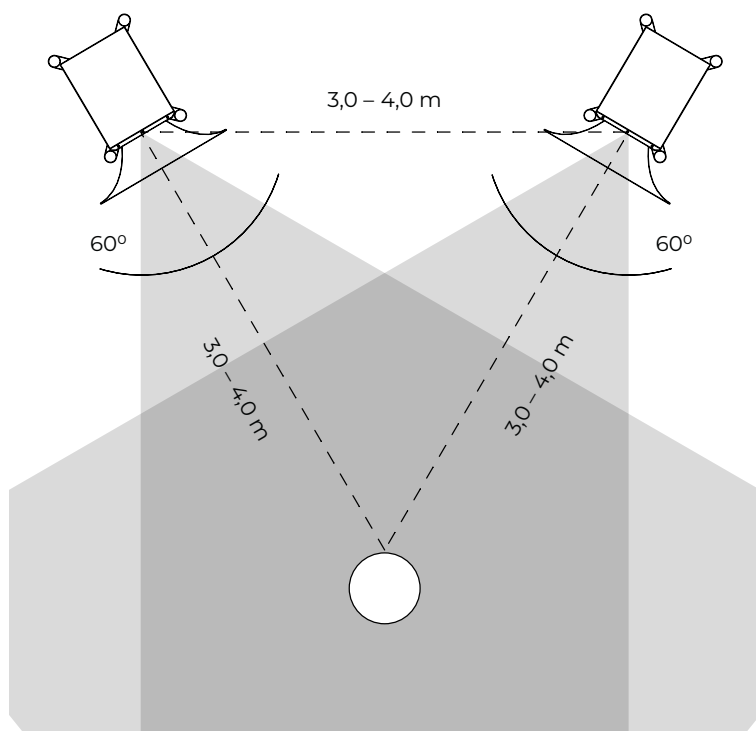

FINE TUNING

TOE-IN & TOE OUT

By facing the speakers inwards (toeing-in) or outwards (toeing-out) you can further affect the focus and tonal balance of the system.

By toeing-out, the sound appears to be less "direct" or "forward sounding", but this may affect the focus of the centre image.

Toeing-in emphasizes increased focus on the centre image, but may affect the width of the stereo image.

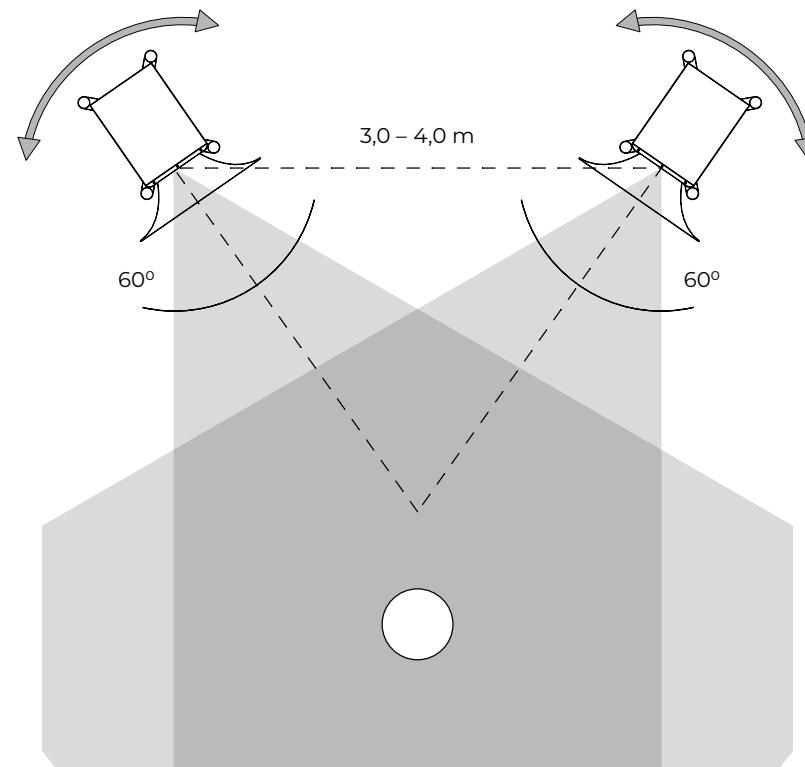

FINE TUNING

LISTENING HEIGHT

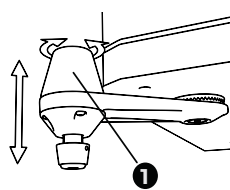

Depending on the listening distance and seat height, it may be important to tilt the speaker systems forward or backward.

If necessary, tilt the speaker slightly forward or backward by turning the handle ❶ of the 4 x spike assemblies until the system is optimally aligned.

RUN-IN TIME

Brand new horns and subwoofers usually need at least 40 hours of running-in. During this period sound quality will improve continuously. Please leave the subwoofers ON during this run-in period.

After this run-in, the sound might have been altered and it might be necessary to slightly re-tune the system set-up (positioning and subwoofer-settings).

WARM-UP TIME FOR ITRON

The ITRON electronics uses pure CLASS-A circuits with Zero-Feedback. To reach its full sonic potential the components need to be fully warmed-up. A sufficient warm up time (> 15 minutes) prior to serious listening is recommended.

MISCELLANEOUS

12V DC TRIGGER

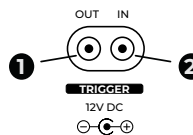

The 12V DC TRIGGER sockets of the ITRON & SPACEHORN electronics features an "IN"-socket ❶ and an "OUT"-socket ❷. This way it is easily possible to remotely switch ON/OFF additional devices (additional SPACEHORNS etc.) by simply daisy-chain the 12V trigger signal.

• Wiring can be made with mono or stereo jack cables.

E-FUSE



All Avantgarde electronics are equipped with a state-of-the-art electronic protection circuit. This E-FUSE continuously monitors the unit and in the event of a fault immediately interrupts the flow of current with unrivaled precision & speed and thus protects the device from damage.

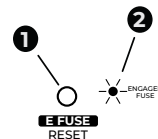

When the E-FUSE has tripped, the current flow will be interrupted and the device stops operating. The red engaged fuse LED ❷ will illuminate. Press the E-FUSE RESET button ❶ to reset. If the E-FUSE keeps tripping, a permanent malfunction has occurred. Disconnect the device from the mains and get it serviced by your dealer.

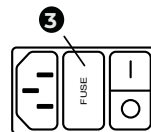

All Avantgarde electronics are equipped with a mains ON-OFF power switch that includes an external fuse holder ❸. In order to avoid any kind of sound degradation, the usual glass-fuse is replaced as standard in all Avantgarde E-FUSE controlled devices by a massive copper bolt to bridge the power.

For whatever reason this copper bolt may at any time be replaced by a conventional (according to the imprint on the device sticker) slow blow glass fuse.

FUTURE UPGRADES *(optional future upgrade only).*



Your system has already been equipped with a wifi antenna port to support future upgrades. This includes remote control signals (from apps etc.) and receiving OTA (over the air) update files for the firmware of the built-in controller chipset.

CLEANING

CLEANING OF HIGH GLOSS LACQUER SURFACES



We recommend to regularly clean high gloss color-coated surfaces (for ex. horns) with a dry soft fabric (duster) or a Rouge-brush.

To remove finger prints and dirty spots we recommend the use of glass detergent.

To remove small scratches we recommend the use of automotive waxes and polishing compounds for cars. Please proceed carefully and strictly follow the cleaning instructions of the manufacturer.

- First apply glass detergent, waxes or polisher on the backside of the horns to test the result!
- Do not touch the membranes while cleaning the horns!
- Avoid scratching the horns with dirty fabrics and never use aggressive detergents or abrasives!

CLEANING OF SATIN-FINISHED LACQUER SURFACES



We recommend to regularly clean satin finished color-coated surfaces (for ex. subwoofer body) with a dry soft fabric (duster) or a Rouge-brush.

To remove finger prints and dirty spots we recommend the use of glass detergent.

- Do not use waxes or polisher!

CLEANING OF METAL SURFACES

Clean the powder coated and anodized surfaces of the frame parts with a regular duster or slightly moisted (i.e. by glass detergent) piece of cloth.

WARRANTY

Avantgarde Acoustic Lautsprechersysteme GmbH warrants that the products are free from defects attributable to faulty manufacture. The warranty is limited to ten (10) years for material fatigue of the metal parts, wooden parts and plastic horn parts, five (5) years for the color coating and drivers, and two (2) years for all electronic components.

All products Avantgarde Acoustic have been thoroughly checked before shipping. In the case of problems, please check the following:

1. This warranty begins on the date of original purchase and may be enforced only by the original purchaser. Please keep the original dated sales slip as proof of warranty coverage. The warranty period is not effected by warranty services provided within the warranty period.

2. Except as specified below, this warranty covers all defects in material and workmanship in this product. Our liability for any defective product is limited to repair or replacement of the products, at our option. Any implied warranties, including warranties of merchantabilities and fitness for a particular purpose, or damages based upon inconvenience, loss of use of the product, or commercial loss, or any other damages are not covered by this warranty.

3. Any modification, alterations or changes to the product are strictly prohibited.

4. In case of defects, please contact at first your dealer. If at the sole discretion of Avantgarde Acoustic it is necessary to ship the product to the manufacturer, please make sure that:

- λ The product is carefully packed and shipped in its original shipping box.
- λ The speaker is properly registered on our website when purchased by the first owner.
- λ The product is shipped free of charge to us, e.g. you must pay all shipping charges (ex. freight, insurance etc.).

5. The following are not covered by this warranty:

- λ Regular inspections, tuning, repairs or replacement of parts which are attributable to normal wear and tear.
- λ Damage occurring during shipment of the product. All transport claims must be presented to the carrier.
- λ Damages or scratches on the surface of the product (ex. housing, horns, metal parts, color coating etc.). These claims must be presented within 3 days after the date of original purchase with your dealer.
- λ Damage resulting from incorrect placement, faulty connections, improper operation. Damage resulting from failure to follow instructions supplied with the product.
- λ Damage resulting from accident, misuse, abuse, neglect, electrical surges, lightning or other acts of God.
- λ Damage resulting from repair or attempted repair by anyone other than Avantgarde Acoustic or an authorized Avantgarde Acoustic dealer.
- λ Consequential, secondary or subsequent damages to other third party appliances.

6. Some states do not allow limitations on how long an implied warranty lasts and/or do not allow the exclusion or limitation of incidental or consequential damages, so the above limitations may not apply to you.

7. Register your new speaker on our website and receive an extension of your factory warranties by 1 year.

www.avantgarde-acoustic.de

Avantgarde Acoustic
Lautsprechersysteme GmbH
Nibelungenstr. 349
D-64686 Lautertal - Reichenbach
Germany



Avantgarde Acoustic GmbH
Nibelungenstrasse 349
D-64686 Lautertal
Germany

Tel: +49.6254.306 100
email: info@avantgarde-acoustic.de
www.avantgarde-acoustic.de